

ECHO-PIEZO TRANSDUCER

B83 SERIES

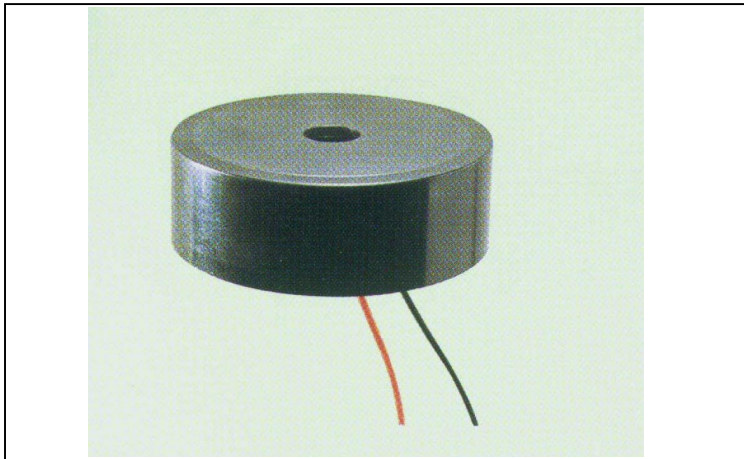

FEATURES:

- Emit a clear penetrating sound
- Ultra small size and lightweight
- Low current consumption
- Extremely durable & long life
- Operating temperature -20°C -- $+70^{\circ}\text{C}$
- Storage temperature -30°C -- $+70^{\circ}\text{C}$

DIMENSIONS: (unit: mm)

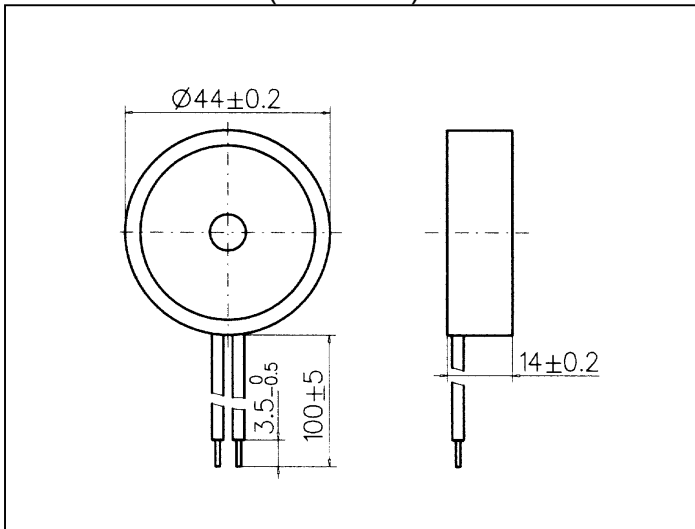

FREQUENCY RESPONSE:

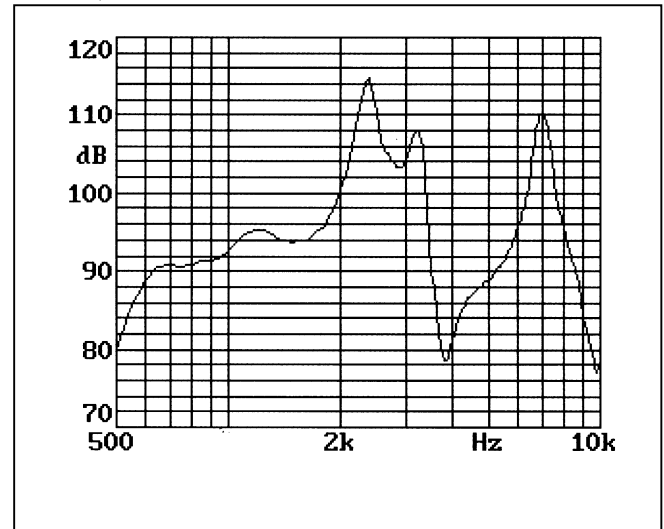

SPECIFICATIONS:

Model Number	B83B01L
Sound Pressure Level	85dBA Min. at 10cm
Static Capacitance	80,000pF \pm 30% at 120Hz
Input Voltage	12Vp-p, 1KHz, Square wave
Max. Input Voltage	30Vp-p
Current Consumption	3mA Max.
Operating Temperature	-20°C ~ $+70^{\circ}\text{C}$
Storage Temperature	-30°C ~ $+80^{\circ}\text{C}$
Weight	10g