

ECHO-PIEZO TRANSDUCER

B87 SERIES

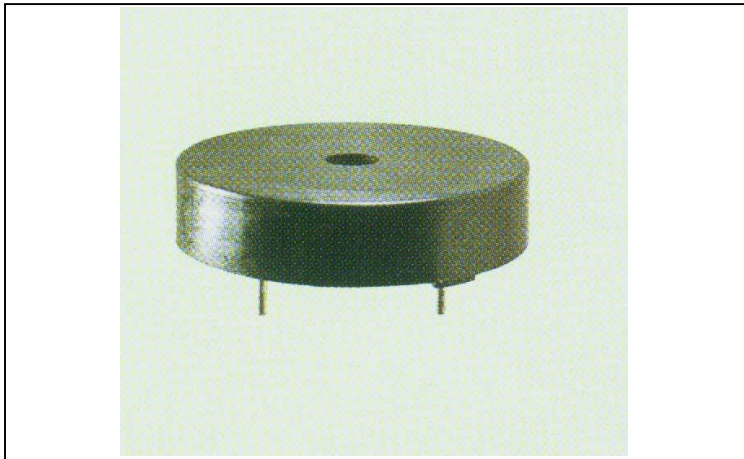

FEATURES:

- Emit a clear penetrating sound
- Ultra small size and lightweight
- Low current consumption
- Extremely durable & long life
- Operating temperature -20°C -- $+70^{\circ}\text{C}$
- Storage temperature -30°C -- $+70^{\circ}\text{C}$

DIMENSIONS: (unit: mm)

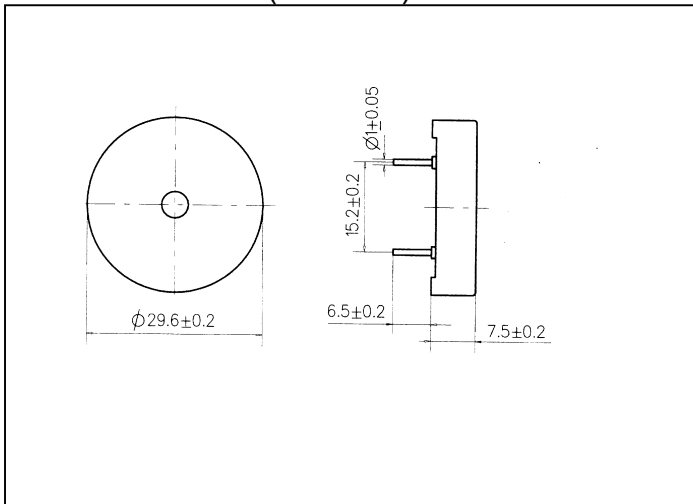

FREQUENCY RESPONSE:

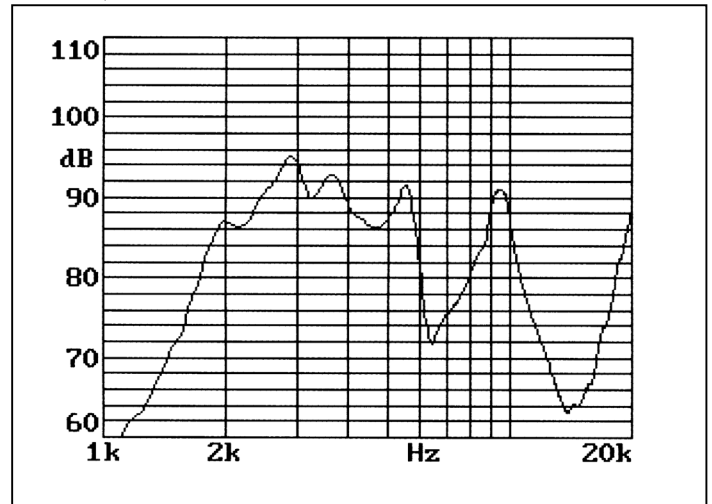

SPECIFICATIONS:

Model Number	B87B03P
Sound Pressure Level	90dBA Min. at 10cm
Static Capacitance	30,000pF \pm 30% at 120Hz
Input Voltage	10Vp-p, 2.8KHz, Square wave
Max. Input Voltage	30Vp-p
Current Consumption	5mA Max.
Operating Temperature	-20°C ~ $+60^{\circ}\text{C}$
Storage Temperature	-30°C ~ $+70^{\circ}\text{C}$
Weight	5g